

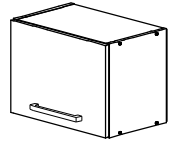

NOVA PLUS NOPL-011-VH

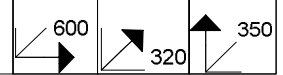

V PRÍPADO REKLAMÁCIE JE POTREBNÉ NAHLÁSIŤ
 VÝROBNÉ ČÍSLO VIDITEĽNÉ NA ETIKETE







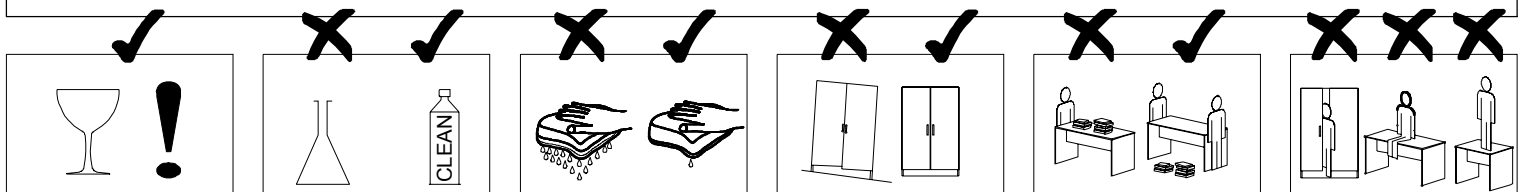
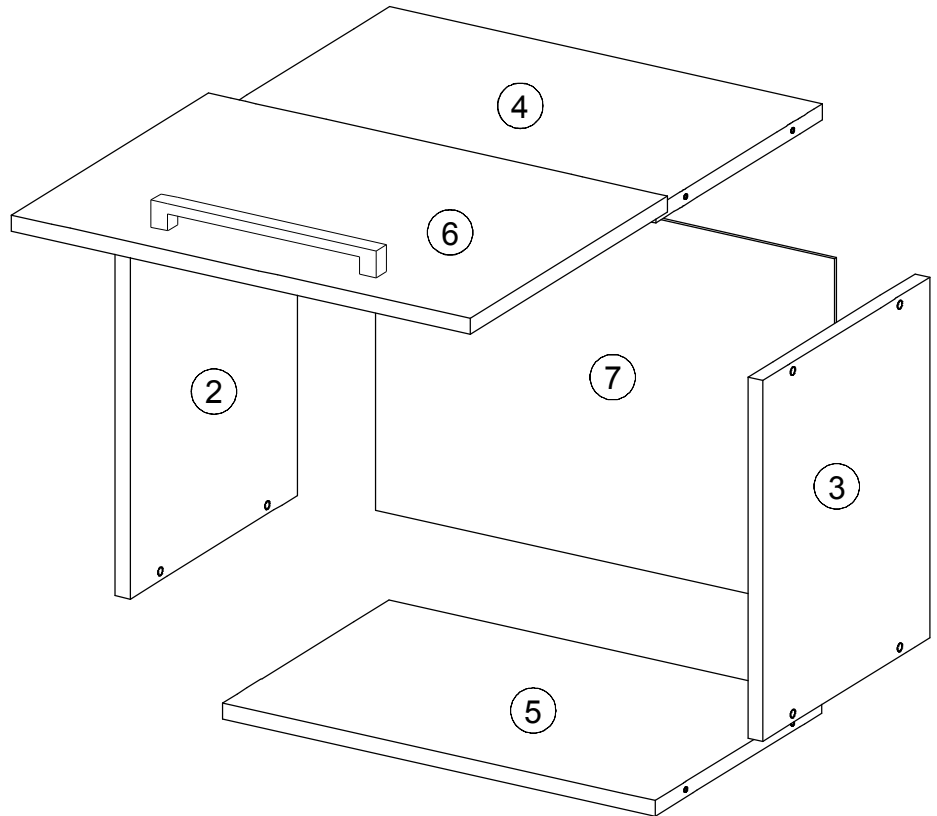

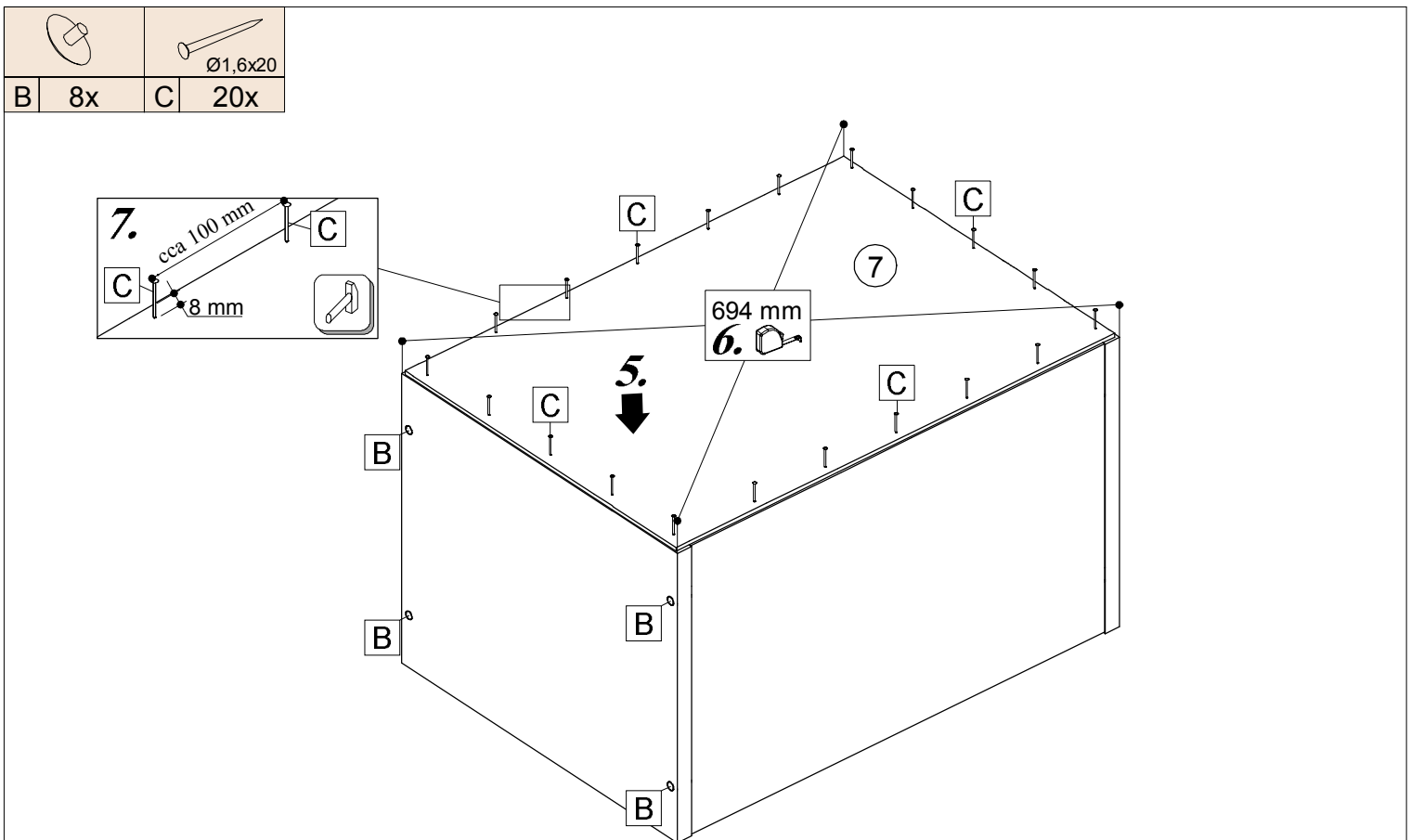
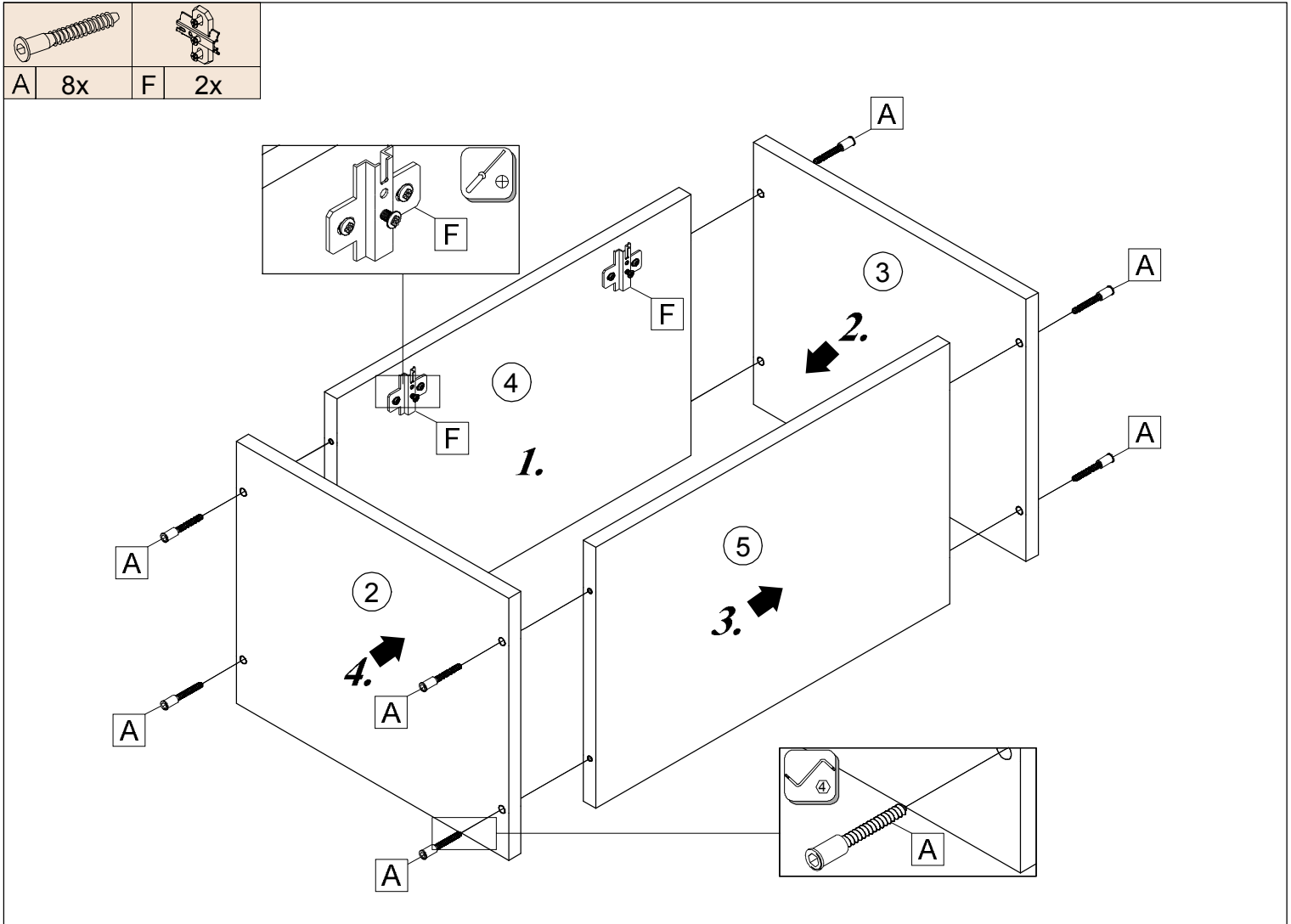
A 8x	B 8x	C 20x Ø1,6x20	D 1x	E 2x	F 2x	G 8x Ø3,5x15	H 2x Ø10	J 2x	K 2x Ø5x60
L 1x	M 1x	N 1x	P 3x Ø3,5x15	R 2x Ø3,5x16					
0h 20min	4		≤ 0,5 kg		3m		Ø10mm		





D	D			
00314	2	350*300*16	1x	1/1
00315	3	350*300*16	1x	1/1
00327	4	568*299*16	1x	1/1
00328	5	568*299*16	1x	1/1
00329	6	344*596*16	1x	1/1
00330	7	345*596*2,5	1x	1/1



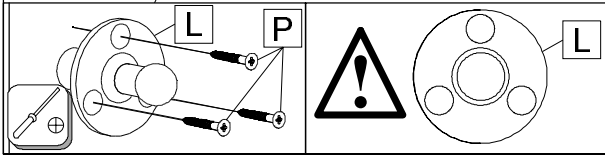
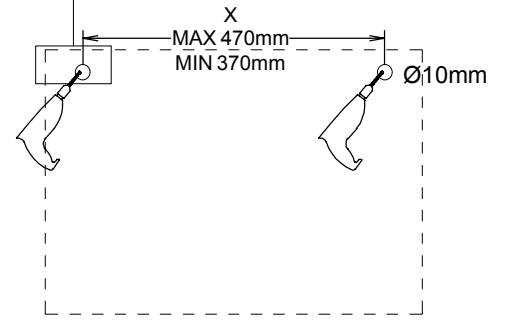
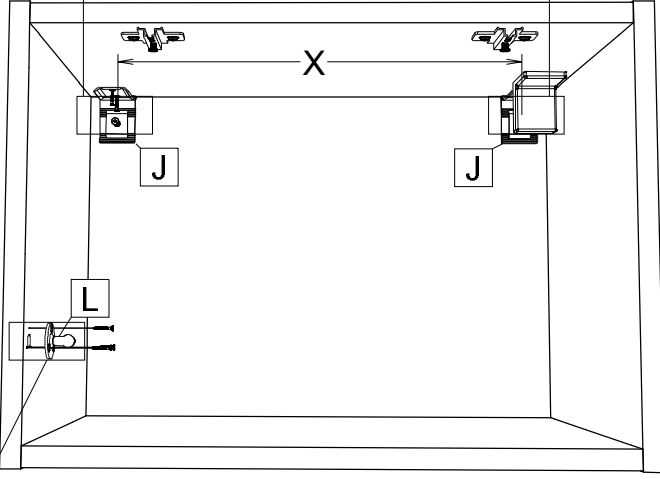
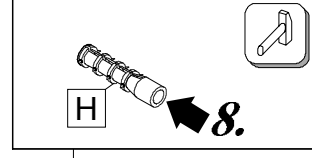
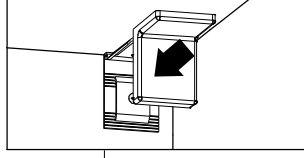
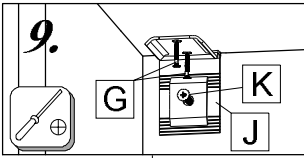

					
Ø3,5x15			Ø5x60		Ø3,5x15
G 4x	H 2x	J 2x	K 2x	L 1x	P 3x



				
		Ø3,5x15		Ø3,5x16
D 1x	E 2x	G 4x	M 1x	R 2x

